

- COMBINED SHOP DRAWING UTILITIES (MEPFS) 3D

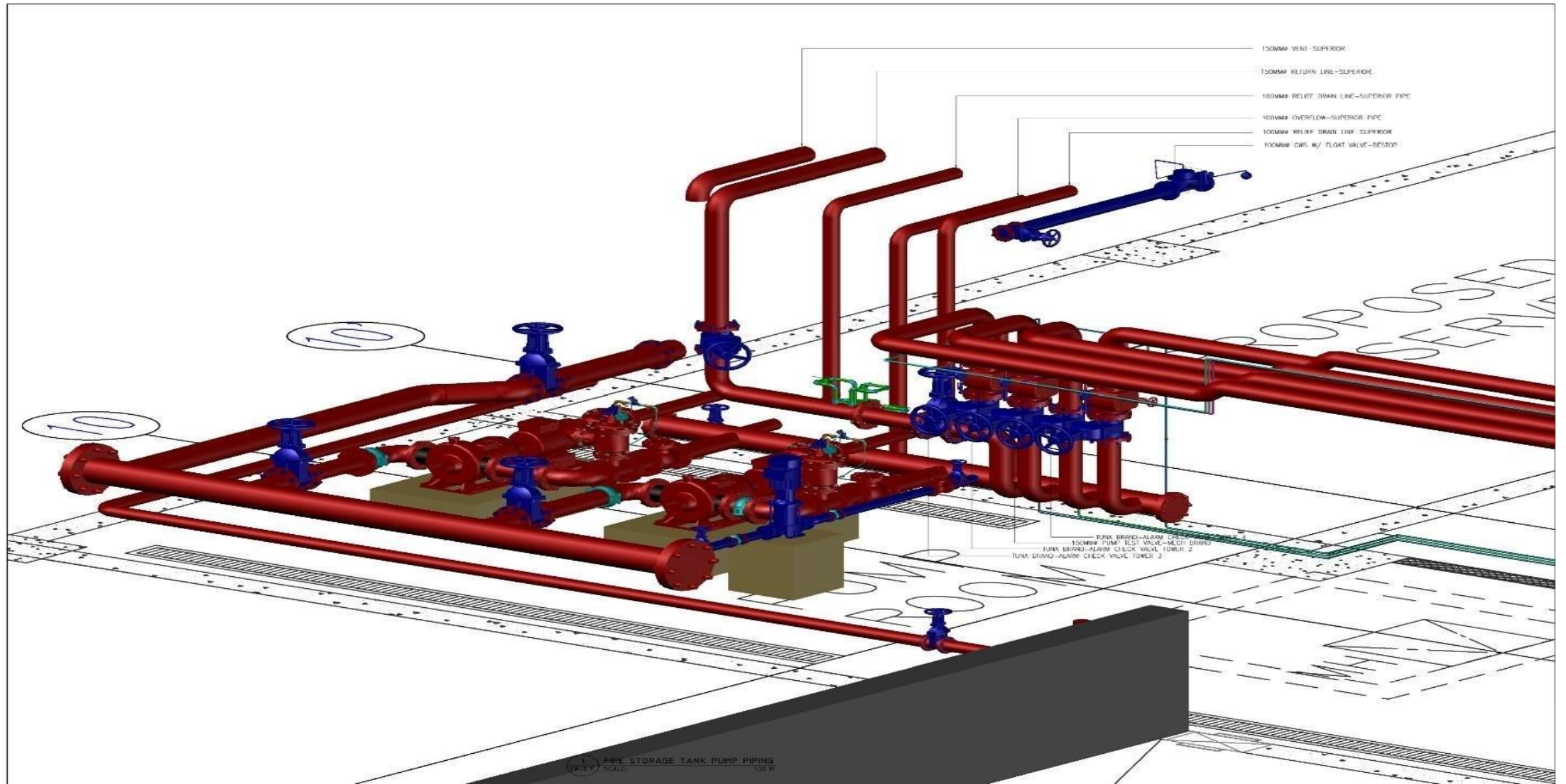

- FIRE PUMP ROOM (3D)

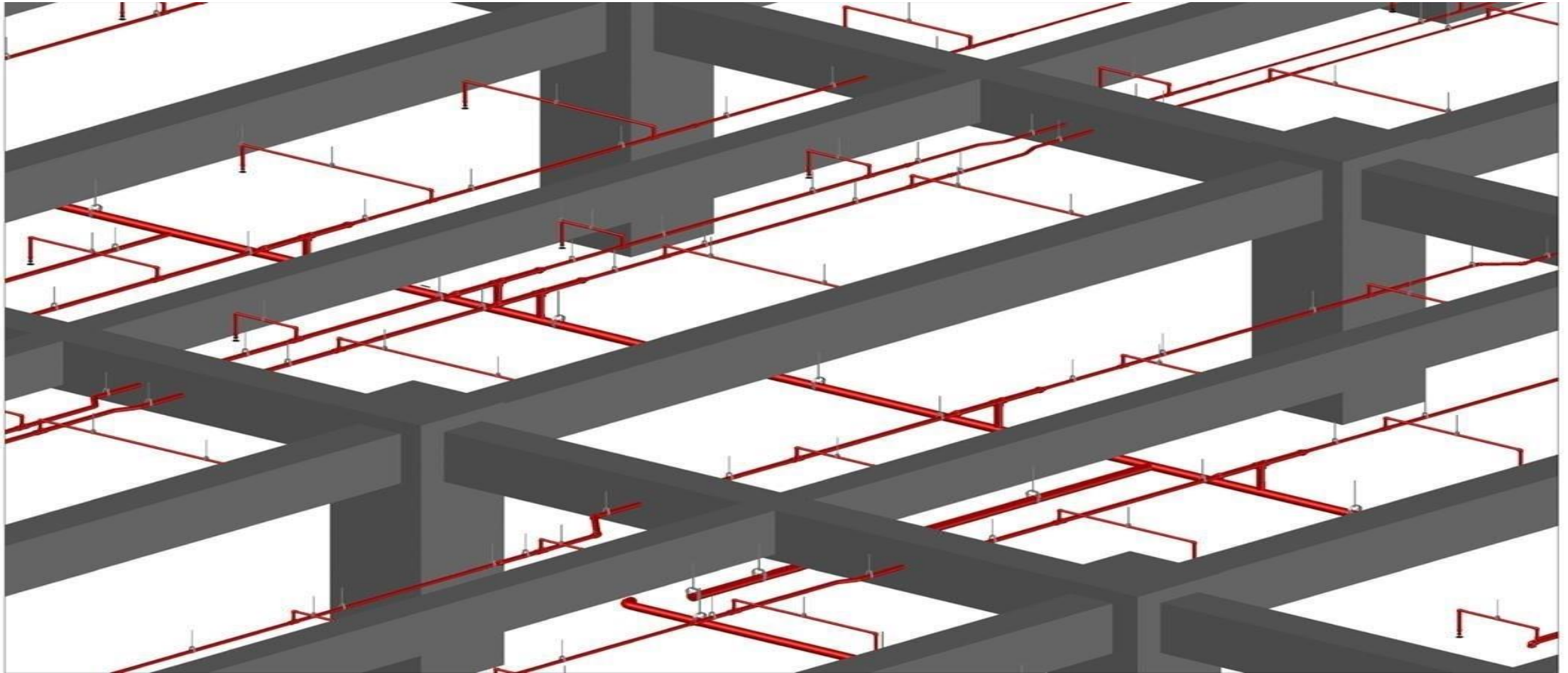

- AUTOMATIC FIRE SUPPRESSION SPRINKLER (3D)

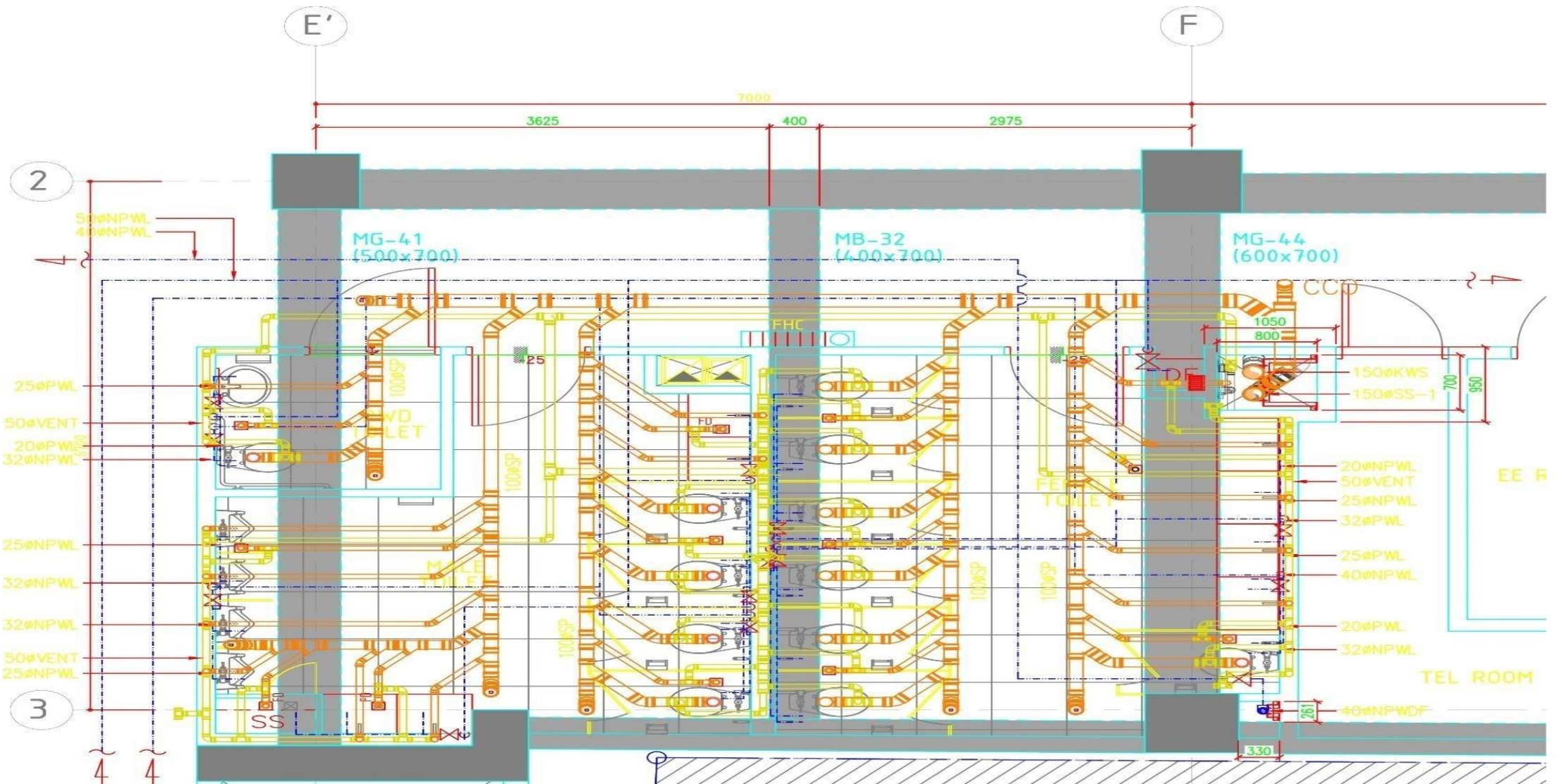

- ROUGHING INS OF SANITARY AT TOILET (2D)

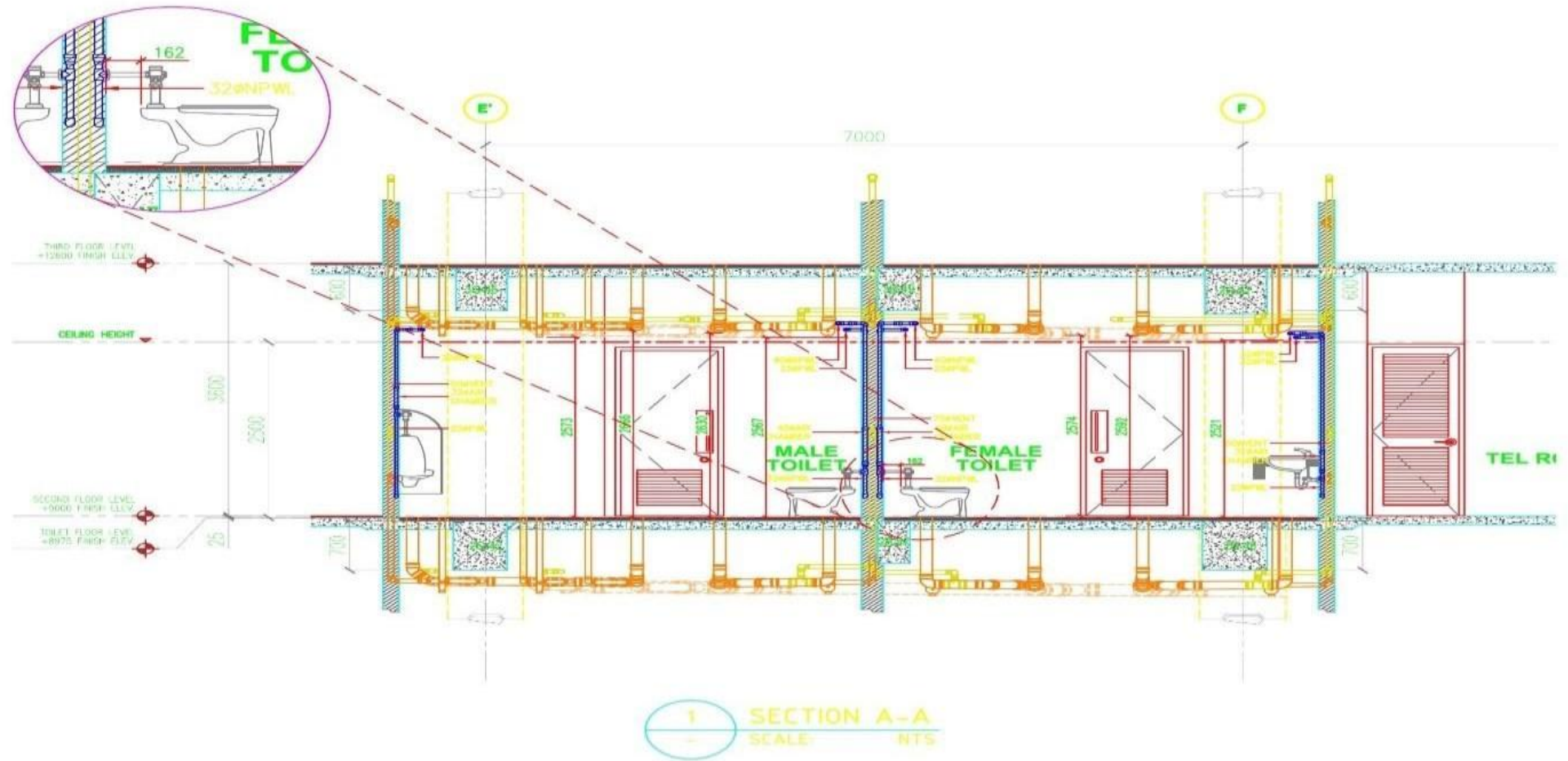

- SECTION AND ELEVATION OF SANITARY AT TOILET

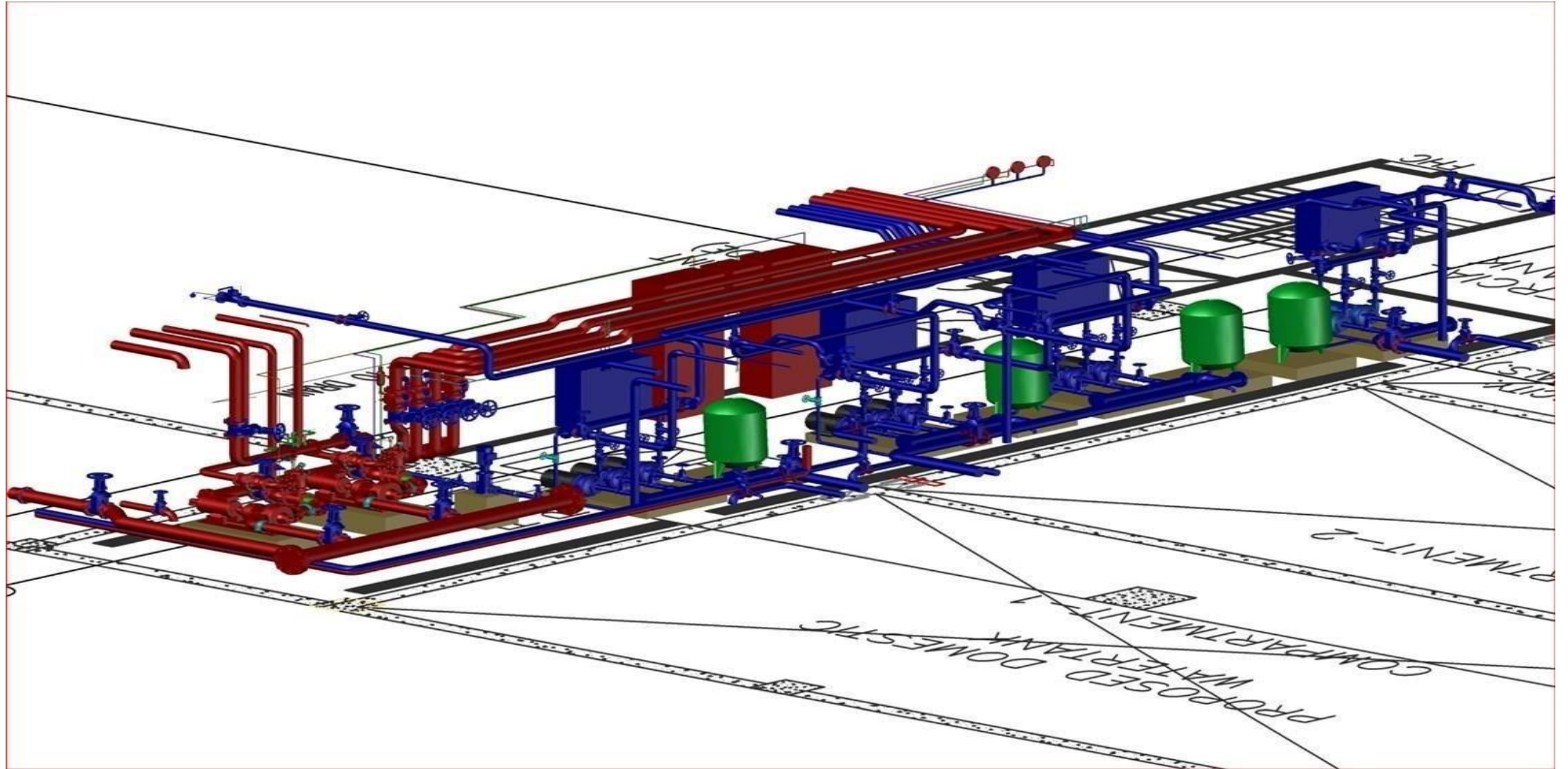

COMBINED SHOP DRAWING OF FIRE PUMP AND DOMESTIC WATER STORAGE PUMP PIPING

JEFFREY GARCIA SAMPLE

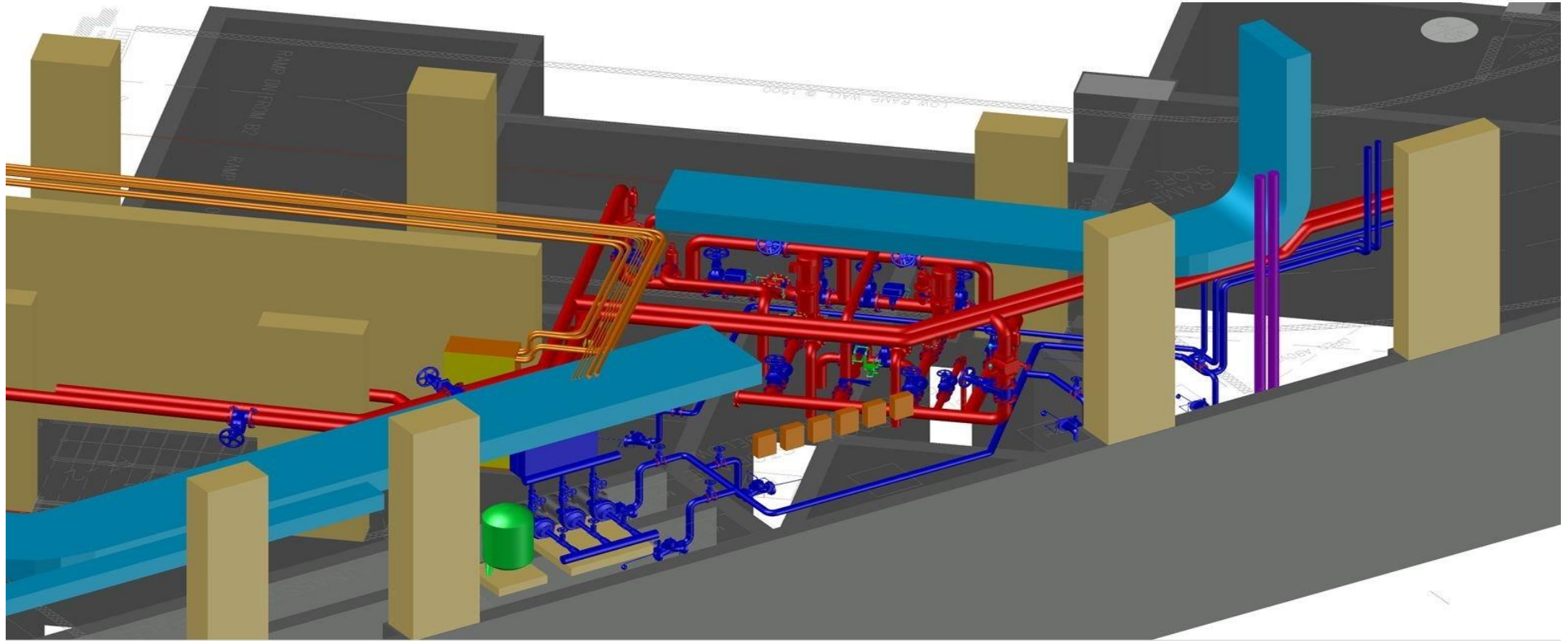

COMBINED SHOP DRAWING OF MEPPS AT PUMP ROOM (3D)

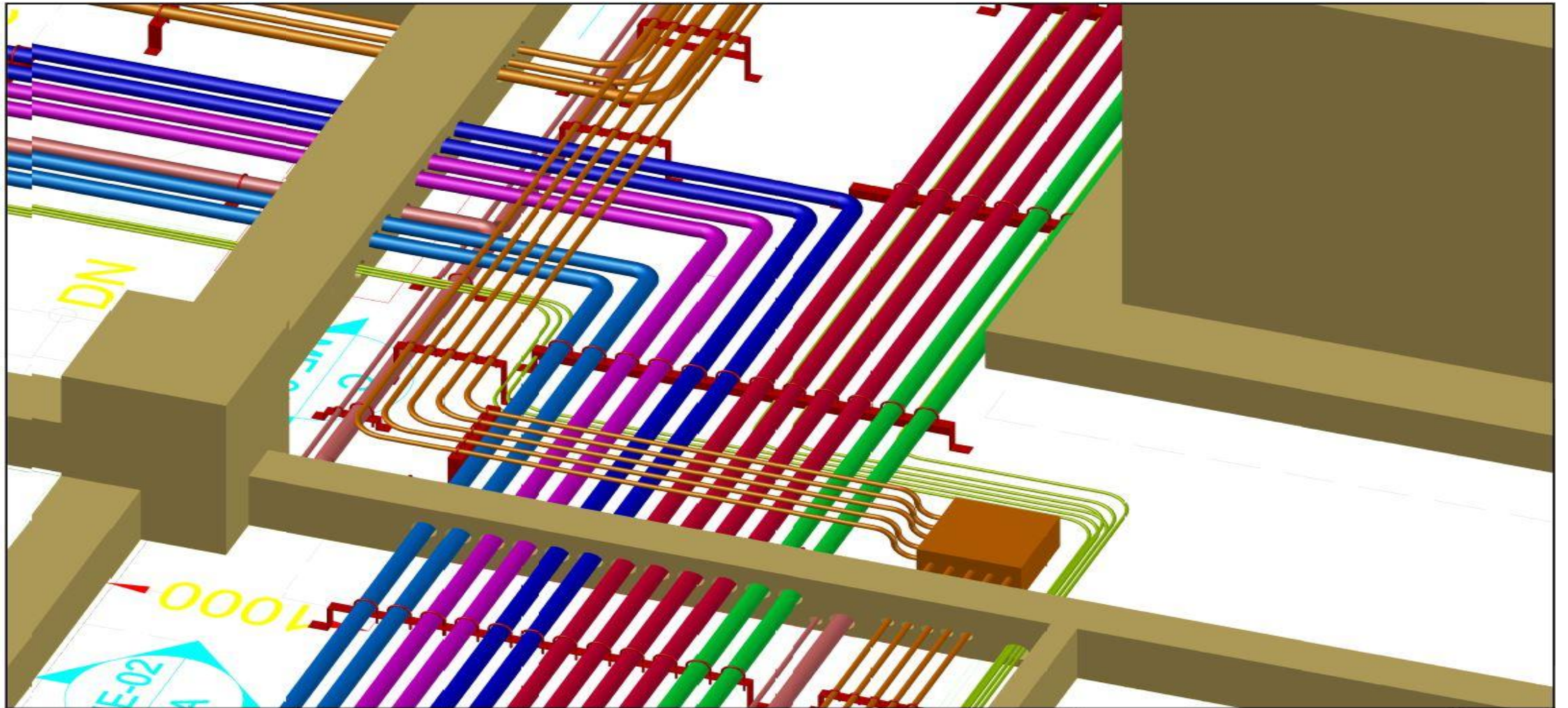

COMBINED SHOP DRAWING OF MECHANICAL REFRIGERANT LIQUID AND GAS AND ELECTRICAL CONDUITS AND CABLE WIRES

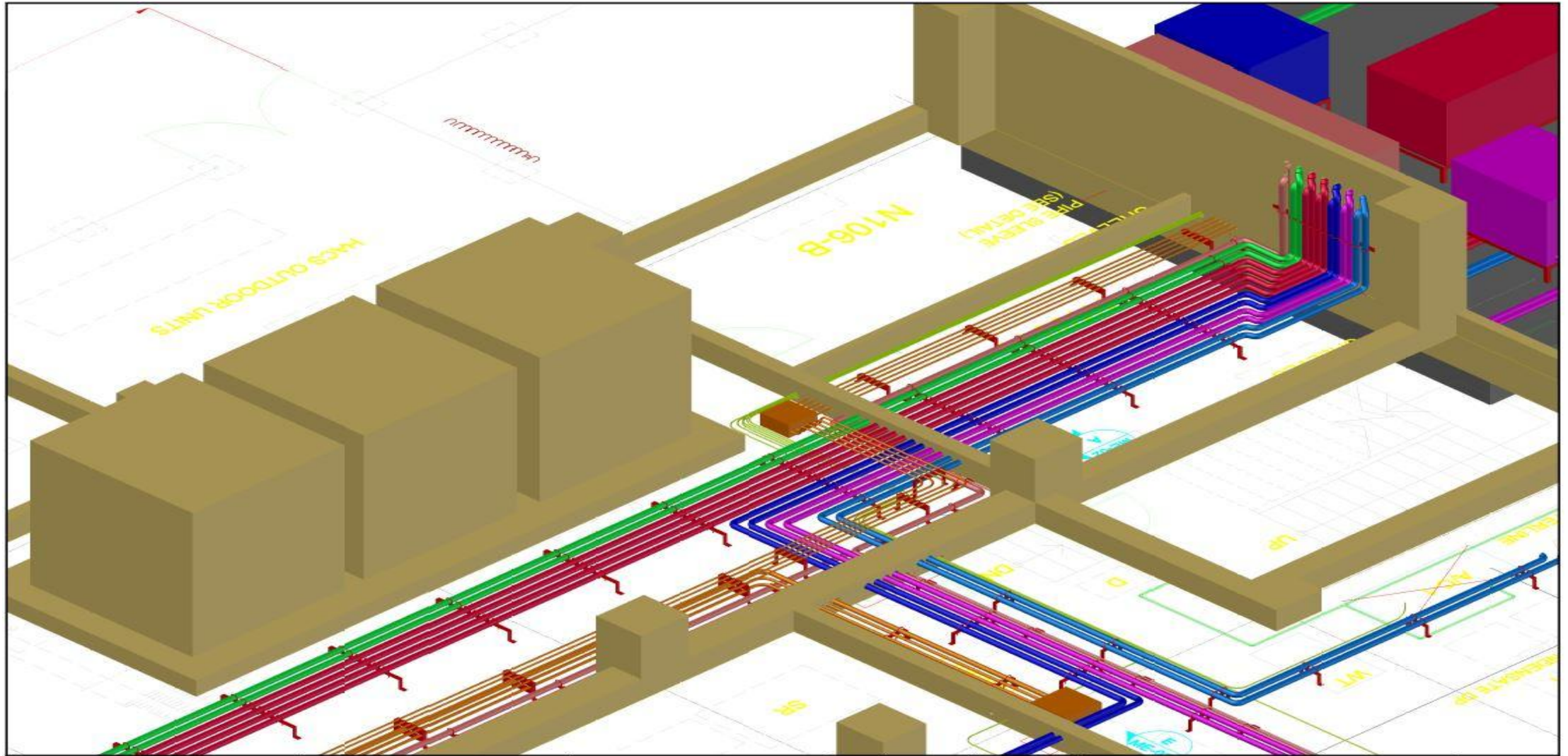

COMBINED SHOP DRAWING OF MECHANICAL REFRIGERANT LIQUID AND GAS AND ELECTRICAL CONDUITS AND CABLE WIRES

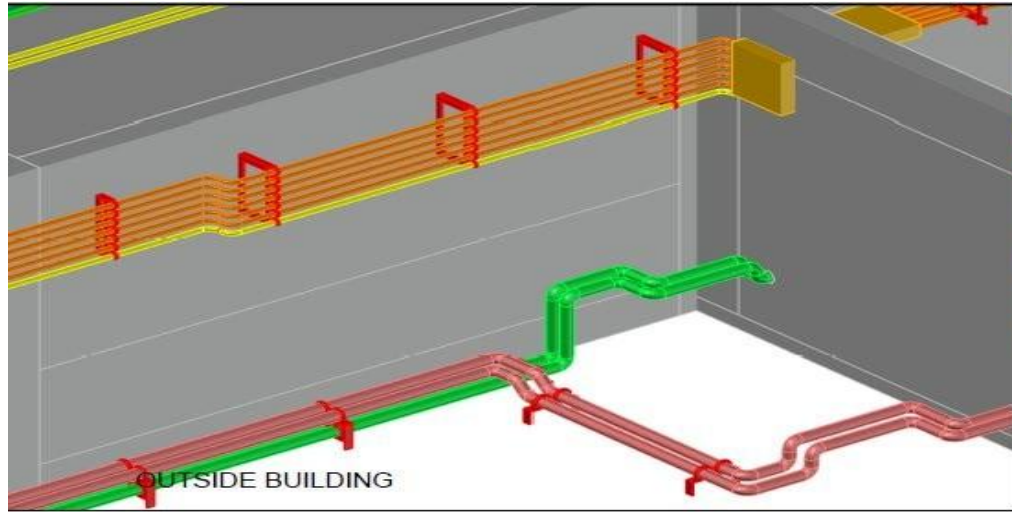

- LEGEND**
- CRAC 1
 - CRAC 2
 - CRAC 3
 - CRAC 4
 - CRAC 5
 - CRAC 6
 - CONDENSATE DRAIN PIPES (0.5% SLOPE)
 - LOCAL CONTROL MANUFACTURER'S NETWORK
 - CONTROL WIRING FOR CRAC UNIT
 - WATERLINE
 - FIRE ALARM
 - ELECTRICAL CONDUITS
 - EE PULL BOX

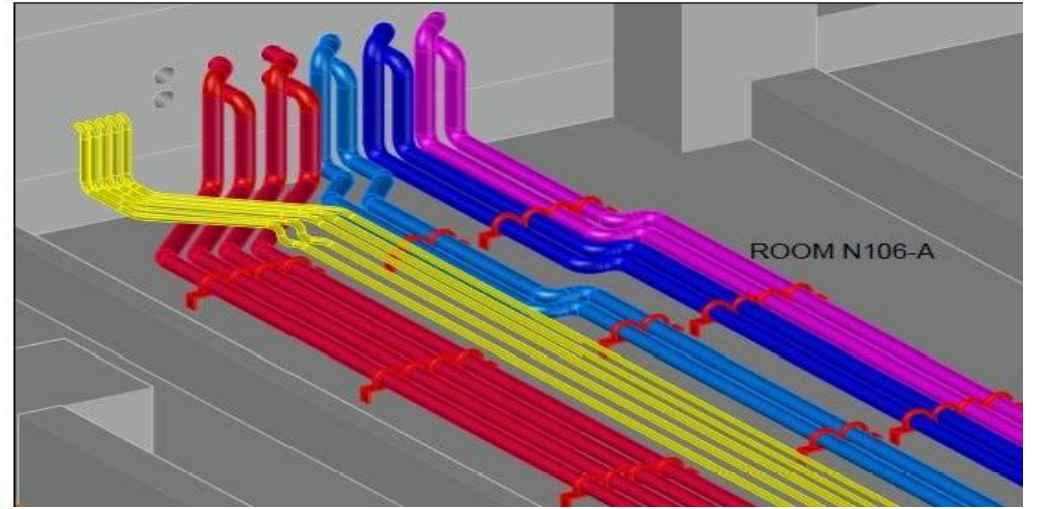
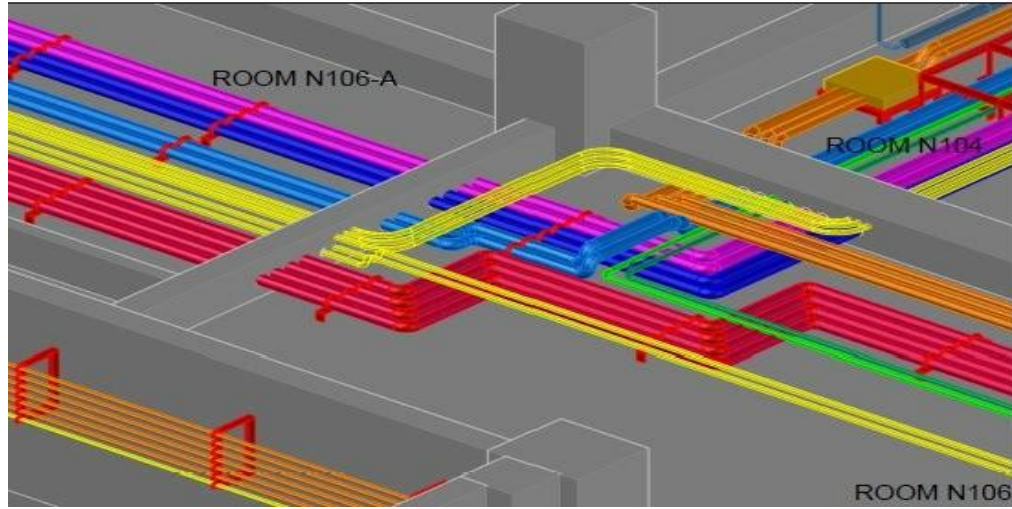
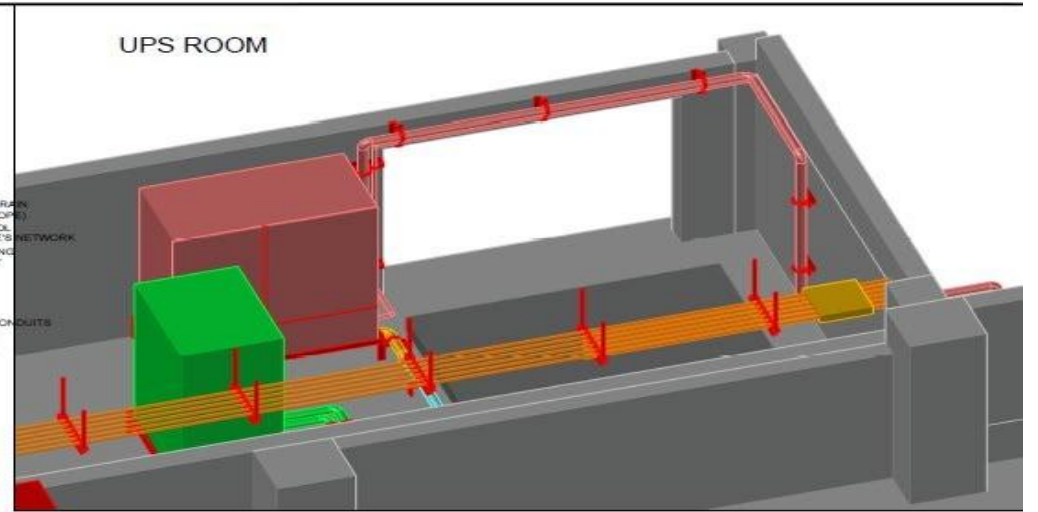

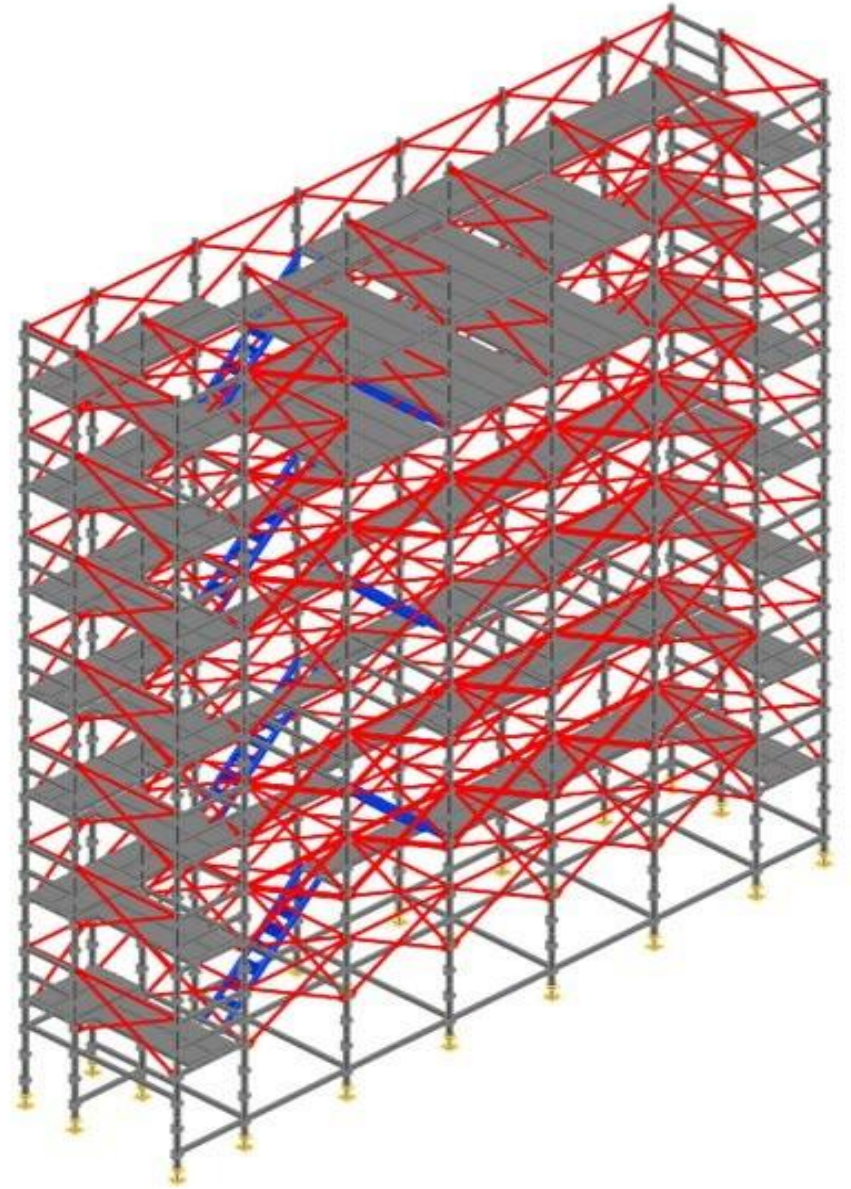
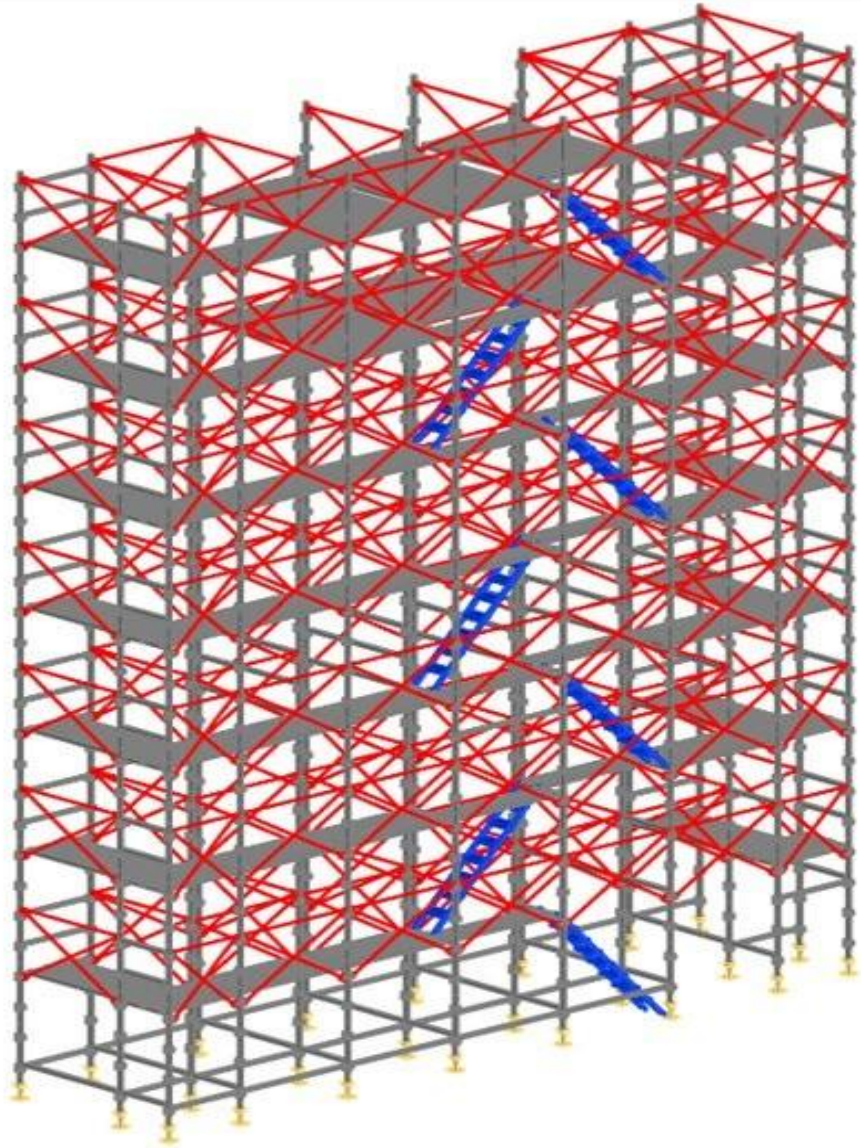

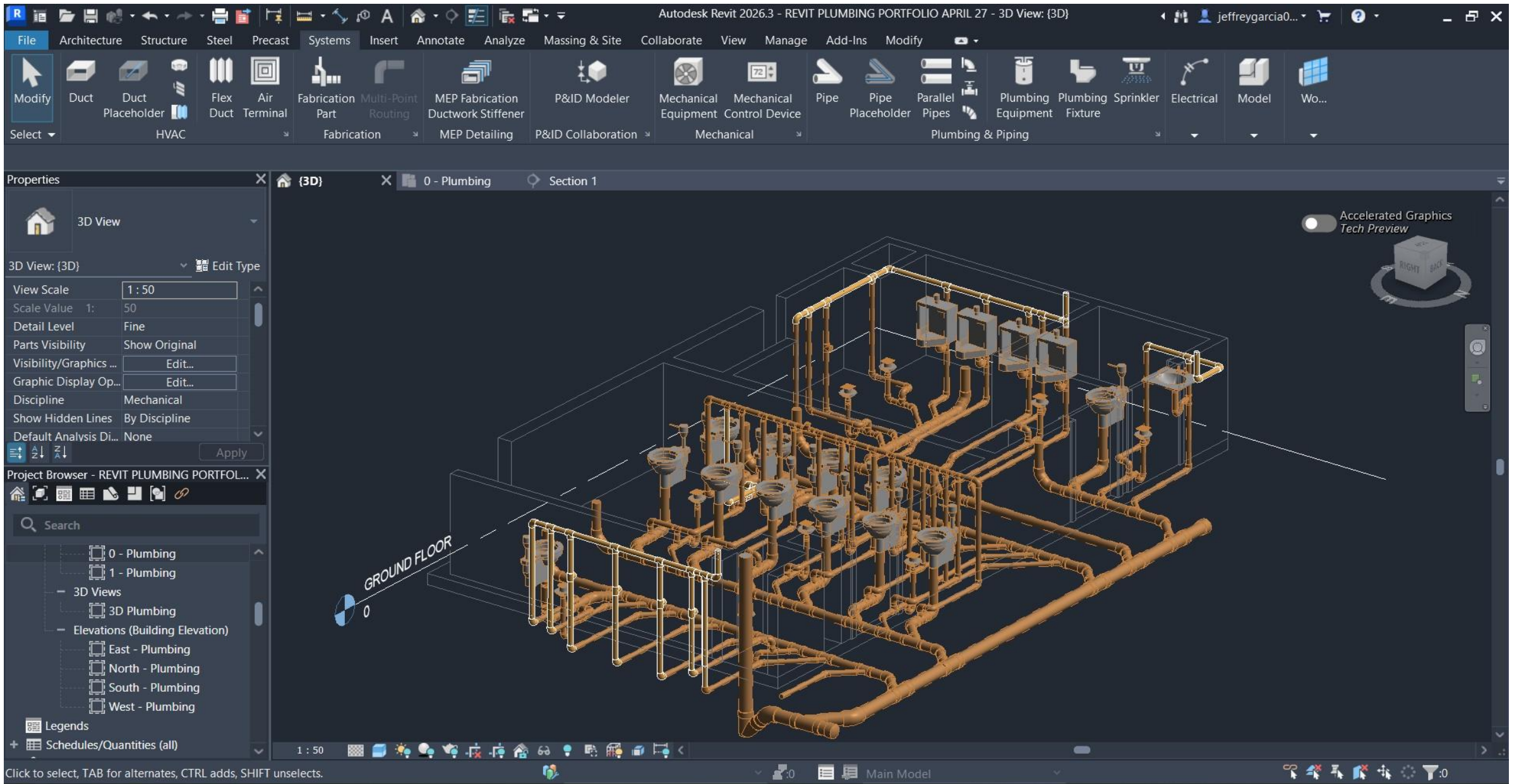

ROUGHING INS OF TOILET (REVIT MEP 2026)